



13<sup>TH</sup>  
EDITION

2023



# CAR & TRUCK REGULATION RALLY

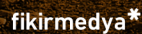

## INDEX

A1.	DEFINITIONS	3
A1.1.	Regulation	3
A1.2.	Route	3
A1.3.	Totals of the Event	3
A1.4.	Average Altitude	3
A1.5.	Terrain (Selective Sections)	3
A2.	ORGANIZATION	3
A2.1.	National Sporting Authority (ASN)	3
A2.2.	Visa Number	3
A2.3.	Organiser's Name, Address and Contact Details	3
A2.4.	Organizing Committee	4
A2.5.	Board of the Stewards	4
A2.6.	Officials	4
A2.7.	Location of the Headquarter (HQ) and Contact Details	4
A3.	PROGRAMME	5
A3.1.	Documentation	5
A3.2.	Briefing	5
A4.	DEFINITIONS	5
A5.	REGISTRATION	8
A5.1.	Registration Dates	8
A5.2.	Registration Procedure	8
A5.3.	Eligible Vehicles	9
A5.3.1.	Groups	9
A5.3.2.	Classes	9
A5.4.	Entry Fee and Other Services	10
A5.4.1.	Details of the Fees	10
A5.4.2.	Payment Infor	11
A5.4.3.	Cancellation and Refund	11
A6.	INSURANCE	11
A6.1.	Compulsory Traffic Insurance	11
A6.2.	Civil Liability Insurance	12
A6.2.1.	Limits of the Insurance Policy	12
A7.	ADVERTISING	12
A7.1.	Restrictions	12
A7.2.	Organizer's Compulsory Plates	12
A7.2.1.	Dimensions of the Compulsory Plates	12
A7.3.	Organizer's Advertising	13
A7.3.1.	Dimensions of Advertising Panels	13
A7.4.	Number Panels and Advertising Scheme	13
A7.5.	Rally Plate and Number Panels Colours	14
A8.	ADMINISTRATIVE CHECK	14
A8.1.	Documents to be Submitted During the Administrative Checks	14
A9.	SCRUTNEERING	14
A9.1.	Technical Specifications, Drivers' Equipment and Safety Devices	15
A9.1.1.	Technical Specifications for Group T-TH-SSV	15
A9.1.1.	Drivers' Equipment	16
A9.1.2.	Safety Equipment	16
A10.	RUNNING OF THE EVENT	17
A10.1.	Crews	17
A10.2.	Race Numbers, Start Intervals and Start Order	17
A10.2.1.	Race Numbers	17
A10.2.2.	Start Intervals	17
A10.2.3.	Start Order	18
A10.3.	Time Card	18

A10.4.	Start and Finish Ceremonies	18
A10.5.	Qualifying Stage Start Procedure	18
A10.6.	Finish Procedure	18
A10.7.	Liaison	18
A10.8.	Time Control Point Procedures	19
A10.9.	Selective Sections	19
A10.9.1.	Selective Section Start Procedures	19
A10.9.2.	Timing in Selective Sections	19
A10.10.	Service Park / Bivouac	19
A10.10.1.	Service Area / Bivouac Locations	20
A10.10.2.	Assistance Crews and People Accompanied by Them	20
A10.11.	Rescue Intervention and Towing	20
A10.12.	Refuelling	20
A10.12.1.	Refuelling Zones	20
A10.12.2.	Points to be Considered During Refuelling	21
A10.12.3.	Refuelling Points to be Setup in Selective Sections	21
A10.13.	Tyres	21
A10.14.	Speed Zones	21
A10.14.1.	Speed Limits for Liaisons	21
A10.14.2.	Speed Restriction in Selective Sections	22
A10.14.3.	Speed Limitation on Bivouac and Service Park	22
A10.14.1.	Way Points	23
A10.15.	Penalties	23
A10.15.1.	Leg Penalties	23
A10.15.2.	Selective Section Penalties	23
A10.15.3.	Payments of Cash Penalties	24
A10.17.	Selective Section Cancellations	24
A2.2.	Tracking system	24
A2.3.	Emergencies	24
A2.3.1.	Incident	24
A10.19.2.	Help to Injured	25
A10.19.3.	Accident on a Road Section	25
A11.	RESTRICTIONS AND OBLIGATIONS	25
A11.1.	Devices Allowed in the Cockpit	25
A11.1.1.	Phones	25
A11.1.2.	Onboard Cameras	26
A11.2.	Devices not Allowed Onboard	26
A11.3.	Prohibition	26
A11.4.	Responsibilities	26
A11.4.1.	Respecting the Environment	26
A11.4.1.1.	Waste Management	26
A11.4.1.2.	Responsibilities for the Environmental Factors	27
A12.	PROTESTS - APPEALS	27
A13.	PRIZES AND PRIZE GIVING	27
A13.1.	Prizes	27
A13.2.	Specifics for the Prize Giving Ceremony	27
A13.3.	Place and Time of the Prize Giving Ceremony	28
	Annex 1 Itinerary	28
	Annex 2 Information about Competitors Relationship Officer	29
	Annex 3 Table of Penalties	31
	Annex 4 Stella Tracking System Manuel	34
	Annex 5 First Aid Kit	39
	Annex 7 Signage	40
	Annex 8 Sportity App	41

## A1. DEFINITIONS

Name of the Event: TransAnatolia Rally Raid  
Dates: 2-9 September 2023

### A1.1. Regulation

TransAnatolia is a rally-raid event which will be organized between 29 – 9 September 2023 on the unique route of Samsun to Izmir.

Modifications, amendments and/or changes to these Supplementary Regulations will be announced only by numbered and dated bulletins which are issued by the Clerk of the Course or the Stewards. For the events not covered by this ruleset 2023 TOSFED Local Baja Prescriptions and 2023 FIA Cross-Country Rally General Prescriptions would be referenced.

Additional information will be published on the official website of the event at [www.transanatolia.com](http://www.transanatolia.com).

### A1.2. Route

TransAnatolia is a rally-type offroad event with the international status where 4x4 and 6x6 all-terrain vehicles along with vehicles modified for desert races called buggy or SSV, and motorcycles can compete together but evaluated under respective categories.

### A1.3. Totals of the Event

Number of Legs	8	
Number of Selective Sections	TBA	
Selective Section	TBA	km
Liaison	TBA	km
Total	TBA	km

### A1.4. Average Altitude

Road Section	TBA	m
Selective Section	TBA	m
Average Altitude	TBA	m

### A1.5. Terrain (Selective Sections)

Gravel	98%
Other surfaces	2%

## A2. ORGANIZATION

### A2.1. National Sporting Authority (ASN)

Türkiye Otomobil Sporları Federasyonu (TOSFED) is the ASN of the event.  
Türkiye Otomobil Sporları Federasyonu  
Levent Mahallesi Ebulula Mardin Caddesi Maya Meridyen Plaza Kat12  
Akatlar / Beşiktaş / İSTANBUL  
+90 (212) 351 50 45 pbx  
+90 (212) 351 50 48  
[info@tosfed.org.tr](mailto:info@tosfed.org.tr)

### A2.2. Visa Number

Approval No: \_\_\_\_\_ Date: \_\_\_\_\_

### A2.3. Organiser's Name, Address and Contact Details

Organizer: Anadolu Spor Organizasyonları Kulübü (ASOK)  
Representative: Orhan Çelen  
Address: Göksu Evleri, İhlamur Cad. Göztepe Mah. A17/A Villa 65 Anadoluhisarı İstanbul – TÜRKİYE  
Phone: +90 (216) 465 13 22  
Fax: +90 (216) 465 03 26  
E-mail: info@transanatolia.com  
Web: www.transanatolia.com

#### A2.4. Organizing Committee

ASOK President: Mr. Orhan ÇELEN  
Clerk of the Course: Mr. Murat DÜRÜSTKAN  
Deputy Clerk of the Course: Prof. Zati VATANSEVER  
Assistant Clerk of the Course: Mr. S. Eray COŞKUN  
Responsible for Marshals: Mr. Y. Caner ÇİFTÇİ  
Assistant Clerk of the Course  
Chief Safety Officer: Mr. Erol KARAÖZ  
Secretary General: Ms. Damla ÇİFTÇİ

#### A2.5. Board of the Stewards

	Name Surname
President	
Steward (TOSFED)	
Steward (ASOK)	

#### A2.6. Officials

	Name Surname
Observer (TOSFED)	

	Name Surname
Clerk of the Course	Mr. Murat DÜRÜSTKAN
Deputy Clerk of the Course:	Mr. Prof. Dr. Zati VATANSEVER
Assistant Clerk of the Course Responsible for Marshals	Mr. S. Eray COŞKUN Mr. Y. Caner ÇİFTÇİ
Secretary General	Ms. Damla ÇİFTÇİ
Chief Safety Officer	Mr. Erol KARAÖZ
Tracking System Officer	Mr. Carlos FIGUEROA
Scrutineer	
Scrutineer	
Chief Medical Officer	Mr. Dr. Ramazan SABIRLI
First Intervention Officer	Mr. Sezer SAYKAL
Secretary to the Stewards	
Competitors Relations Officer	Ms. Elif TANCA Mr. Yiğit TOP
Results Officer	Mr. Burak Emre GEÇER
Bivouac Coordinator	Mr. Tolga KİRAZ
Rescue Chief	Mr. İbrahim GÖKKAYA
Media Officer	Mr. Gökhan BAŞIPLIKÇI
Logistics / Bivouac Officer	Mr. Levent GÜL

#### A2.7. Location of the Headquarter (HQ) and Contact Details

HQ: Bivouac – Bus (Motorhome)

Address:

Phone: +90 538 441 58 20

E-mail: info@transanatolia.com

HQ Working Hours:  
Official Notice Board (ONB)  
Digital Notice Board (DNB)

TBA.  
31 August - 9 September 2023  
Between 15 April - 9 September 2023

HQ + Sportity App  
[www.transanatolia.com](http://www.transanatolia.com)

### A3. PROGRAMME

1 February 2023 Sunday	Opening date for entries
	Opening date for entries with reduced pricing
31 May 2023 Wednesday	Ending of 2 <sup>nd</sup> reduced entry term
15 August 2023 Tuesday	17:00 Closing date for entries
28 August 2023 Monday	Publication of the entry list
1 September 2023 Friday	12:00 Administrative checks begin (On appointment)
	12:00 Scrutineering begins (On appointment)
2 September 2023 Saturday	08:00 Administrative checks begin (On appointment)
	08:00 Scrutineering begins (On appointment)
	16:00 Parc Ferme (For all vehicles by latest)
	16:15 Briefing
	18:05 1 <sup>st</sup> leg Ceremonial Start
	18:15 Qualifying Stage
3 September 2023 Sunday	08:00 2 <sup>nd</sup> leg Samsun - Tokat
4 September 2023 Monday	07:00 3 <sup>rd</sup> leg Tokat – Sivas
5 September 2023 Tuesday	07:00 4 <sup>th</sup> leg Sivas - Kapadokya
6 September 2023 Wednesday	09:00 5 <sup>th</sup> leg Kapadokya - Haymana
7 September 2023 Thursday	10:00 6 <sup>th</sup> leg: Haymana - Afyon
8 September 2023 Friday	07:00 7 <sup>th</sup> leg: Afyon – Simav
9 September 2023 Saturday	07:00 8 <sup>th</sup> leg: Simav – Izmir
	Finish Ceremony

#### A3.1. Documentation

The road book for the next leg will be distributed at the end of each day by replacing the ending leg's at the Bivouac entrance. Results are published at 20:00 on the notice board. Start list for the next leg will be published at the end of the day on the notice board.

#### A3.2. Briefing

Event officials will organize a briefing before the start of the first leg. Time and location of this briefing will be announced later. The presence of at least one member of each crew is compulsory (signature) on pain of a penalty of **€100.00**.

During the rally, a briefing will be held the night before each Leg, in the Bivouac or in the hotel in a designated location. Briefing will be held daily at 21.00. The presence of at least one member of each crew is compulsory (signature) on pain of a penalty of **€25.00**.

Announcements concerning safety or changes in the roadbook will be published in the notice board by the Clerk of the Course in the form of signed and numbered documents before the briefing, or by latest at the end of the briefing. Competitors are responsible for the recovery of information given by organisers.

### A4. DEFINITIONS

#### Bulletin

Official written document intended to modify, specify or complete the Regulations of the rally.

ASN

5

National Sporting Authority duly recognized by the FIA.

### **Service**

Service shall be defined as unrestricted work on a competing vehicle, or one of its elements, even when dismantled. The rules to be followed for service vehicles and crews are detailed in article **A10.10** of the regulations.

### **Bivouac**

Zone situated between the Time Controls at the finish of one Leg and the start of the next, where all competitors regroup; this zone is located in the road book. In the bivouac, servicing is free between the competitors still in the race and with vehicles and/or people registered in the assistance category. It is a closed area, checked and secured, reserved for private use during the event, whose access is exclusively and uniquely for persons who have been accredited by the organisation, as well as representatives of authorities.

### **Briefing**

Organizers' official notifications and warnings will be made at the briefings to be held at the end of each leg, except otherwise specified. (A briefing will be held before the event, where the event specific matters and regulations in general will be outlined.)

### **Time Card**

A card intended for the entry of times, recorded at the different control points, scheduled on the itinerary, signed when necessary.

### **TC (Time Control - CH)**

Marshal posts where time controls are carried out. Refer to **A10.8**

### **Communication / Information Note**

Communication: Official informative document published by the Clerk of the Course or the Stewards, posted on the notice board at the competitors' disposal, against compulsory signature.

Information Note: Document published by the organisers, posted on notice board and at the competitors' disposal.

### **Competitor**

Physical or legal entity used for the physical or legal person who has entered the vehicle.

### **Disqualification**

Disqualification means that a person or persons may not continue to participate in a Competition. This decision is immediately enforceable and terminates the insurance policy for the competitor concerned.

### **Duration of the rally**

The rally starts with the administrative checking and scrutineering and ends upon the expiry of one of the following time limits, whichever is the later.

- Time limit for protests or appeals or at the end of any hearings by the stewards;
- End of the post event scrutineering, if it is in place
- End of the prize-giving.

### **Crew**

The crew consists of persons competing inside the vehicle.

### **Leg**

Each part of the Event that is separated from the next by at least 8 hours.

### **Official Time**

The official time is the GPS time.

The target check-in time is the responsibility of the crews alone, who may consult the official clock on the control point.

### **SZ (DZ)**

The start of a speed control zone is indicated on the road book and, when possible, marked by a precise reference marker and by a WPS or WPE. In case of discrepancy between the two, the waypoint will be binding.

### **FZ**

End of a speed control zone marked by WPE.

### **Speed Control Zone**

When Stella tracking device is in operation a signal is generated in every 90 meters. Each infringement exceeding the maximum speed allowed in one and the same speed control zone, defined by a SZ and an FZ will be recorded. In case of a repeated offense during the event, the 3rd infringement (in 3 different zones) will result, for all competitors, in penalties that may go as far as disqualification, depending on the excess speed noted.

### **Neutralization**

Time during which the crews are stopped by the Race Direction for whatever reason, parc fermé rules apply in these cases. This time is the same for all competitors.

### **Officials**

The Stewards, Scrutineers, Clerk of the Course, Deputy Clerks of the Course and all the other persons working under the supervision of the Clerk of the Course.

### **Parc Ferme**

Area in which no service, preparation, presence nor intervention is possible, except in the case of art. **A10.10**.

### **Route**

Defined by the road book, checked by the crew of the road opening car. The route is divided into legs consisting of one or more selective sections linked by road sections (liaisons).

### **Headquarters (Race Control - HQ)**

Race control (sports and safety), coordination and management of interventions. Working hours of the HQ is published in the programme.

### **Disqualification from a Selective Section**

It means selective sections which aren't completed (started or finished) are included in the standings by adding the relevant penalties depending on the pro times of the stages.

### **Leg Penalty**

Time penalty to be added to the competitors' results at the end of the day who didn't complete a leg or any stage within the leg.

### **Sporting Penalty**

A sporting penalty means a penalty imposed for: speeding, missing a PC, or Waypoint, or unsporting conduct, or other violation committed on a Selective Section or a liaison.

### **Regrouping**

**a)** A halt scheduled by the Organisers to enable the theoretical times to be observed on the one hand and, on the other, to regroup the crews still competing. The regrouping time may vary according to the crews.

**b)** The new start will be given according to the order of arrival at the entrance of the regrouping Time Control. Start times will be given according to the start list intervals and order, if necessary.

### **Road Book**

Each crew will be given a road book, in the size of A5, comprising a maximum of 5 horizontal lines of distances, drawings and information, containing characteristic notes and/or compulsory points of passage (WPV's, WPM's, WPS's, WPE's, DZ's, DZS's, FZ's, CP's, CH's) which must be validated on pain of incurring penalties up to and including disqualification.

### **Road Section (Liaison)**

Section of itinerary with a target time between two successive Time Controls where national traffic laws are enforced.

### **Selective Section**

Speed test in real time. Selective Sections may be run over a course exclusively reserved for the competitors however, competitors should mind that TransAnatolia is an open road event. Starts of Selective Sections are preceded by or twinned with a Time Control and followed by a Flying Finish after the Stop.

### **Qualifying Stage**

There might be a qualifying stage. In case, it'll be run to determine the start order for the following Leg. It counts for the classification.

For the Qualifying Stage, timing will be taken to the tenth of a second. If the event is timed to the second, the tenths of a second are rounded down to the nearest second once the starting positions for the following Leg have been determined.

### **Running of the Qualifying Stage**

- The organisation of a Qualifying Stage (QS) is optional.
- It's mandatory to start the Qualifying Stage.
- Starting order of the QS will be determined with respect to the classes of the competing vehicles. CoC can suggest amendments on the starting order if necessary and suggests it to the Stewards.
- This stage is considered as the first selective stage of the event.
- In case the QA cannot be run, CoC determines the starting order and suggests it to the Stewards.
- It is to be run with a minimum length of 2 km and a maximum length of 20 km. Only one Qualifying Stage may be organised.

### **Estimated Time**

Time estimated by the Organiser to cover a Selective Section.

Competitors failing to reach the Flying Finish point of a stage within the estimated time will be disqualified from the respective stage.



Estimated times will be indicated in the itinerary and time cards.

### **Target Time**

Each Road Section or the distance from one Start to the next Time Control will be covered within the given target time, which the competitors must imperatively respect.

Any crew arriving earlier or later than the target time on the Time Control will incur a penalty given to each minute.

### **Maximum time allowed**

It is calculated for each Time Control point by adding 30 minutes to the Target Time of that point.

### **Closing Time**

It is calculated for each Time Control point by adding 30 minutes to the Target Time of the last competitor started the stage. When this time arrives Time Control points on the stage will be closed.

Closing times for Flying Finish and Stop points are calculated based on the start time of the last competitor by adding the target time.

### **Real Time**

This is the time actually taken by the competitor to cover the route of a Selective Section.

### **Vehicle**

Any SSV, car or truck entered in the rally, passing through the Scrutineering, complying with the criteria detailed in the current Regulations and its appendices and having the crew on board.

### **Waypoint (WP)**

A waypoint is a geographical point defined by coordinates of latitude and longitude. There are 4 types of waypoints: WPV, WPM, WPE, WPS. Each waypoint noted on the road book is a compulsory passage point to be validated.

### **WPE (Eclipse waypoint)**

Waypoint memorised in the GPS and indicated in the road book, and the coordinates of which are not revealed to the competitors. Waypoint towards which the GPS, with all its capacities displayed on its screen, directs the competitor once the waypoint preceding this WPE has been validated, whatever the distance between the waypoint and the WPE, thus the GPS directs the competitor towards this point. Starts of selective sections will be WPEs. To validate their passage at a WPE, competitors must pass within at least 90 metres to it.

### **WPM (Hidden waypoint)**

Waypoint memorised in the GPS and indicated in the road book, and the coordinates of which are not revealed to the competitors. The GPS directs the competitor towards this point only once they have come within a 1 kilo meter-radius of it. To validate their passage at a WPM, competitors must pass within 90 metres to it.

### **WPS (Way point safety)**

Waypoint memorised in the GPS and indicated in the road book, and the coordinates of which are not revealed to the competitors. It can be linked to a danger (!!!), crossings of roads, pipelines, railways, cliffs, etc.

The GPS directs the competitor towards this point only once he has come within a 3km radius of it. To validate their passage at a WPS, competitors must pass within at least 90 metres to it.

### **WPV (Visible waypoint)**

Waypoint which coordinates are given by the road book. Towards a visible way point, all available information is displayed on the screen of the "GPS". Starts and finished of legs are WPV's. To validate their passage at a WPV, competitors must pass within 90 metres to it.

### **PC (Passage Control)**

A control zone to check competitors being on track or to control a section of the route.

#### **A5. REGISTRATION**

##### **A5.1. Registration Dates**

Entries can be submitted at a reduced fee between 15 February 2023 and 31 May 2023. Normal entry fee is applied afterwards until 15 August 2023, closing date of the entries. Registration closes on 15 August 2023 at 17:00 (GMT+3).

Organizers will accept a limited number of entries not to cause issues on the running of the event. Entries submitted afterwards will be evaluated and the organizers hold the right to refuses the entries.

##### **A5.2. Registration Procedure**

Competitors willing to submit their entries must fill the online form available at [register.transanatolia.com](https://register.transanatolia.com) website with the driver's, co-driver's, assistance and vehicle details.

Original entry form must be delivered to the organization during the administrative check.

Complying with deadlines is imperative, whether it regards payments or information and / or documents to be sent to the organization.

TransAnatolia disclaims any responsibility for administrative complications if required information has not been provided on time.

Drivers must hold a valid **Offroad** or **Baja Sporting License** valid for 2023. Licenses should be presented by latest administrative check.

Sending the payment receipts for the registration fee and the insurance to [info@transanatolia.com](mailto:info@transanatolia.com) is imperative for each competitor. Entry will be considered only once the payment is received.

Entries missing the payments would be disregarded.

The Organizing Committee reserves the right to refuse the entry of a driver, co-driver, or a competitor, according to their specific selection criteria.

During administrative checks, each participant will have to sign a “commitment contract”, on which they undertake to:

- abide by the current regulations,
- abide by the laws in force in the Republic of Turkey,
- guarantee the accuracy of the information given on vehicles and crews,
- present at any time their vehicle complying with the regulations,
- be in possession of all the necessary administrative documents and be solely responsible for their validity.

By the very fact of signing the “commitment contract”, the competitor, all the crew members and team members submit themselves to the sporting and technical Regulations of TransAnatolia. They unreservedly agree to comply with the provisions of Supplementary, Technical and Service regulations including their appendices, as well as with any decisions from the Clerk of the Course or the Stewards including the Bulletins.

Each participant is aware of the responsibilities that any breach of those rules could entail.

More information about the registration procedures can be requested from the Competitors Relations Officer.

Documents to be presented during the administrative check are listed on **Art. A8.1**

### **A5.3. Eligible Vehicles**

#### **A5.3.1. Groups**

- **Group T1**
- **Group T2**
- **Group T3**
- **Group T4**
- **Group T5**
- **Group TH**
- **Group SSV**

#### **A5.3.2. Classes**

Group	Class	Vehicle
FIA T1	T1.U	“Ultimate” Prototype Cross-Country Vehicles - 2023 Appendix J, Art. 285-12
	T1+	Prototip 4x4 Cross-Country Vehicles - 2023 Appendix J, Art. 285-11
	T1.1	Prototip 4X4 Cross-Country Vehicles - 2023 Appendix J, Art. 285 / 2009 Appendix J, Art. 285 (Art. 8.4)
	T1.2	Prototip 4x2 Cross-Country Vehicles - 2023 Appendix J, Art. 285 / 2009 Appendix J, Art. 285 (Art. 8.4)
	T1.3	Vehicles conforminh with “SCORE” regulations (Art. 8.5)
	T1.4	Production Vehicles with Expired Homologation - 2022 Appendix J, Art. 284 (Art. 8.6.1)
FIA T2	T2	Production Vehicles – 2023 Appendix J, Art. 284

FIA T3	T3.U	“Ultimate” Light Prototype Vehicles – 2023 Appendix J, Art. 286-14
	T3.1	Light Prototype Vehicles – 2023 Appendix J, Art. 286
FIA T4	T4	Modified Production SSV– 2022 Appendix J, Art. 286A
FIA T5	T5	Cross Country Trucks
ASN TH	Sinif 1	4x4 – up to 1750cc (up to 1029cc with turbo/supercharge) petrol, up to 2000cc (up to 1333cc with turbo/supercharge) diesel
	Sinif 2	4x4 - 1751-2800cc (1030-1647cc with turbo/supercharge) petrol, 2001-3500cc (1334-2333cc with turbo/supercharge) diesel
	Sinif 3	4x4 - 2801-3949cc (1648-2323cc with turbo/supercharge) petrol, 3501-4399cc (2333-2933cc with turbo/supercharge) diesel
	Sinif 4	4x4 – larger than 3950cc (larger than 2324cc with turbo/supercharge) petrol, larger than 4400 cc (larger than 2934cc with turbo/supercharge) diesel
	Kamyon	4x4 or 6x6 serial production trucks
	SSV	SSV’s conforming with TOSFED’s Group SSV technical regulations

The coefficient to be used to determine the atmospheric equivalents of supercharged and turbocharged engines is **1.5** for diesel and **1.7** for petrol engines.

The minimum number of competitors to open FIA T1-T2-T3-T4 groups is 3. If the relevant class cannot be opened, the vehicles in question will be included in the corresponding classes in the ASN groups.

#### A5.4. Entry Fee and Other Services

##### A5.4.1. Details of the Fees

Fee	February - March	April - May	June - July
<b>Car / SSV Rally</b>	3.900,00 €	4.150,00 €	4.400,00 €
<b>Truck Rally</b>	4.000,00 €	4.250,00 €	4.500,00 €
<b>Extra Person / Mechanic</b>	1.000,00 €	1.200,00 €	1.400,00 €
<b>Assistance Vehicle (Car or Caravan) + Driver</b>	1.200,00 €	1.350,00 €	1.500,00 €
<b>Assistance Vehicle (Truck &lt; 3500 Kg) + Driver</b>	1.300,00 €	1.450,00 €	1.600,00 €
<b>Assistance Vehicle (Truck &gt; 3500 Kg) + Driver</b>	1.400,00 €	1.550,00 €	1.700,00 €
<b>Guest (With Own Car)</b>	1,000 €	1,200 €	1,400 €
<b>Guest (Including Transfer)</b>	1,200 €	1,400 €	1,600 €
<b>Stella GPS System Rental Fee</b>			339.00 – 375.00 €
<b>Stella GPS System Bracket Fee</b>			100.00 €

#### Entry Fee Includes:

- Hotel accommodation (breakfast + dinner) in double rooms
- Bivouac accommodation (breakfast + dinner + hot showers + toilets) (on your tent or caravan)
- Documents
- Road books + GPS points
- Public Liability insurance
- Rescue interventions in emergencies
- Water supply
- Value added tax
- Transportation of damaged vehicles to the nearest main road if the capacity of the rescue team allows it

#### Entry Fee Excludes:

- Transfer to/from the starting/finish point
- Compulsory traffic insurance
- Personal health insurance
- Fuel
- Assistance
- Hotel accommodation costs for bivouac nights or camping equipment and installation and transportation of those
- Single room fee
- Early check-in or late checkout from the hotel
- Airport transfer
- Tracking system and its installation

#### **A5.4.2. Payment Infor**

Entry fee must be paid with wire transfer. Payment receipt must be presented with the entry form. All entry fees must be paid by bank transfer, to the following bank accounts.

##### **Euro Account**

**Bank:** DenizBank A.Ş.  
**Branch:** Kavacık, İstanbul  
**Beneficiary:** TransAnatolia Spor Organizasyonları Ltd. Şti.  
**IBAN:** **TR48 0013 4000 0600 0846 4000 03**  
**Swift:** DENITRIS241

##### **Turkish Lira Account**

**Bank:** DenizBank A.Ş.  
**Branch:** Kavacık, İstanbul  
**Beneficiary:** TransAnatolia Spor Organizasyonları Ltd. Şti.  
**IBAN:** **TR05 0013 4000 0600 0846 4000 01**

- Entry fee must be paid in full by latest the closing date of the entries. Entries not accompanied by a payment will be refused.
- Any bank charges incurred must be paid by the entrants in addition to the entry fees.
- A copy of the proof of payment must be presented in the administrative check.
- Please ensure that the reference number obtained from the registration system is included as a reference on all bank transfers.

#### **A5.4.3. Cancellation and Refund**

Entry fee will be refunded in full

- to candidates whose entry has not been accepted.
- if the event is cancelled.

In the case if a competitor withdraws their entry before the closing date of the entries, 50% of the entry fee will be refunded.

If the event will be postponed the organizers will immediately inform each competitor about the new dates and the programme. Competitors who can't compete in the new dates can apply for a refund within 5 days after receiving the postponement notification. 50% of the entry fee will be refunded to those if their request is accepted.

If the event is postponed due to a force-majeure situation, the organizer makes a refund payment programme in 1 calendar year or offers those competitors entry to the next event.

In the case of a serious problem, justified by medical opinion (original document), the partial repayment can be made if the organizer accepts the conditions stated by the competitor.

Crews refused a start due to failure to pass the pre-event scrutineering will not be eligible for refunds. This applies to the crews which decide to withdraw after the scrutineering.

In all cases participants may not claim any other types of refund of funds paid.

No refund is offered for cancellations after 15 August.

## **A6. INSURANCE**

### **A6.1. Compulsory Traffic Insurance**

In accordance with the laws in force in the Republic of Türkiye each competitor must hold a valid traffic insurance policy. If a competitor is participating in the event with a vehicle registered in a foreign country scope of the insurance must cover Türkiye in accordance with the current regulations in force.

Each competitor must present the insurance policy during the Administrative Check.

## **A6.2. Civil Liability Insurance**

Entry fee includes civil liability insurance in accordance with the laws in force in the Republic of Turkey.

Competitors, drivers and vehicle owners waive their rights to file a claim against the organizer for damages that may occur by submitting and entry.

Policy's validity begins with the start of the event and only covers Qualifying, Spectators' Special Stage, Selective Sections. Validity of the policy terminates when the event finishes or halts.

Assistance vehicles, even those bearing special plates issued by the organizers, may never be considered as official participants in the rally. They are therefore not covered by the insurance policy of the rally and remain the sole responsibility of their owner.

In liaisons (sections other than the selective sections) race vehicles' own insurance policies are valid and the organizers has no responsibility.

### **A6.2.1. Limits of the Insurance Policy**

Only damage caused to third parties by the competitors are covered in accordance with the 2nd article of the 2022 TOSFED Supplementary Prescriptions by the Organization's insurance policy.

Validity of the policy begins with the start of the event and terminates at the end of the event or when the crew retires.

<b>Limits</b>	
<b>Material Damage per Vehicle</b>	₺120,000.00
<b>Material Damage per Incident</b>	₺240,000.00
<b>Physical Damage per Person</b>	₺1,200,000.00
<b>Physical Damage per Incident</b>	₺6,000,000.00

## **A7. ADVERTISING**

### **A7.1. Restrictions**

According to the laws in force in the Republic of Turkey advertising of tobacco products and alcoholic beverages are forbidden. Provisions of this law applies to the assistance vehicles and team clothing.

Competitors can affix any advertising on their vehicle if it is:

- It does not interfere with the crew's vision through the windows,
- Allowed by the Turkish legislation,
- Is not contrary to good morals and customs,
- It does not express either a religious and/or political opinion.

### **A7.2. Organizer's Compulsory Plates**

Organizers will issue a set of 1 rally plate, 2 number plates and 2 windshield and rear window numbers to each crew.

Rally plate and the competition numbers must be affixed to the vehicle during the event according to this regulation. Vehicle's registration plate must not be covered.

#### **A7.2.1. Dimensions of the Compulsory Plates**

For Cars and Trucks (T1 + T2 + T5 + ASN Groups)

2 Number Plates	: 42 cm (width) x 44 cm (height)
1 Rally Plate	: 43 cm (width) x 21 cm (height)
2 Windshield and Rear Window Numbers	: 20 cm (width) x 10 cm (height)

For SSV's (ASN SSV + T3 + T4 Groups)

2 Number Plates	: 30 cm (width) x 31 cm (height)
1 Rally Plate	: 19 cm (width) x 18 cm (height)
2 Windshield and Rear Window Numbers	: 20 cm (width) x 10 cm (height)

Rally plate must be positioned legibly in a visible position during the whole event. They must be fixed at the front, without covering, even partially, the vehicle's license plates, and, except for the manufacturer's acronym, the plate must be the first inscription legible from the front.

Competitors are responsible for affixing the number panels neatly and visibly without modifying them.

At any time during the event, the absence or faulty positioning of a rally plate or number panel may incur, on certification, a cash penalty equivalent to **10%** of the entry fee.

Names of the drivers and their blood types, plus their national flags must appear on both sides of the front wings or front doors of the vehicle. Any vehicle failing to comply with this rule may be subject to a cash penalty, equivalent to 10% of the entry fee.

### A7.3. Organizer's Advertising

Sponsors' stickers should be affixed to the car along with rally plate and number plates before the scrutineering.

It is competitors' responsibility to keep those panels visible during the event.

Plates and advertising stickers cannot be cut into pieces. They should be affixed as they were delivered and according to the scheme given during the administrative check.

#### A7.3.1. Dimensions of Advertising Panels

For Cars and Trucks (T1 + T2 + T5 + TH Groups)

2 Advertising Panel : 42 cm (width) x 44 cm (height)

For SSV's (ASN SSV + T3 + T4 Grpups)

2 Advertising Panel : 30 cm (width) x 31 cm (height)

If compulsory advertising is absent or wrongly affixed, a penalty of **10%** of the entry fee per person will be incurred for the first offense, and **20%** of the entry fee for each repeated offense.

### A7.4. Number Panels and Advertising Scheme

1. Number panels to be affixed left and right sides of the vehicle
  2. Competition numbers to be affixed to the windshield and the rear window
  3. 1 rally plate to be affixed to the front of the vehicle
  4. Optional advertising panels to be placed next to the number panels
- Competitors refusing organizer's advertising must pay **€1,000.00**.

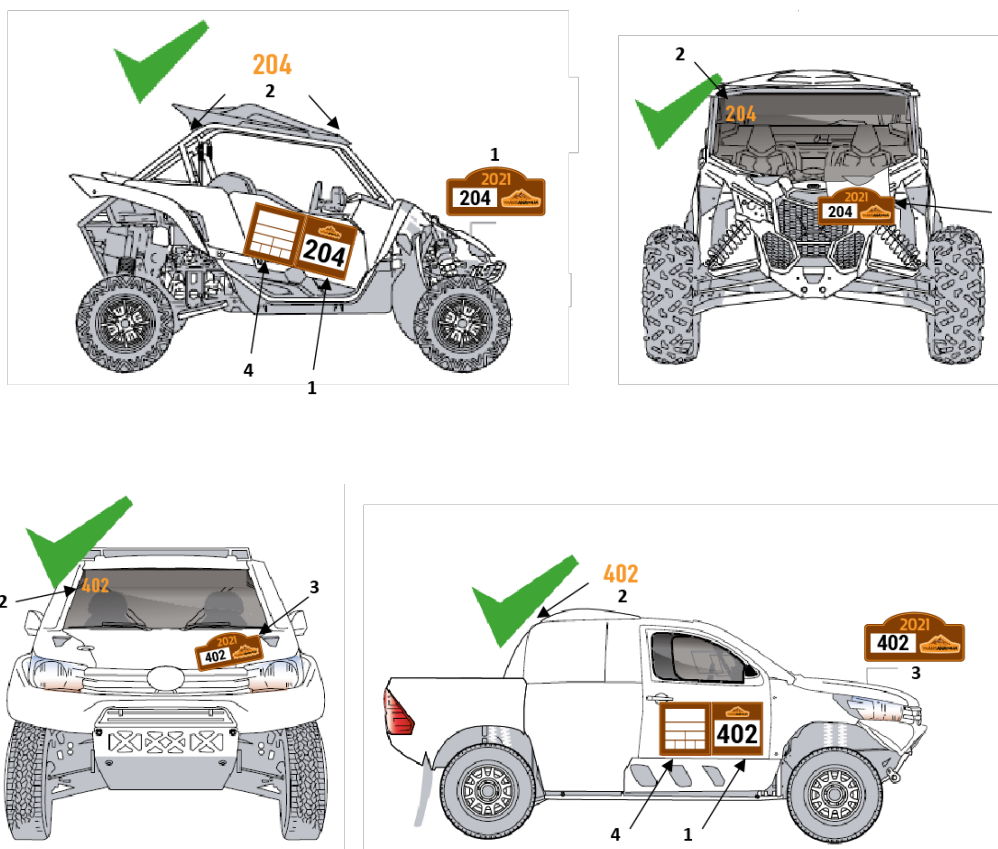

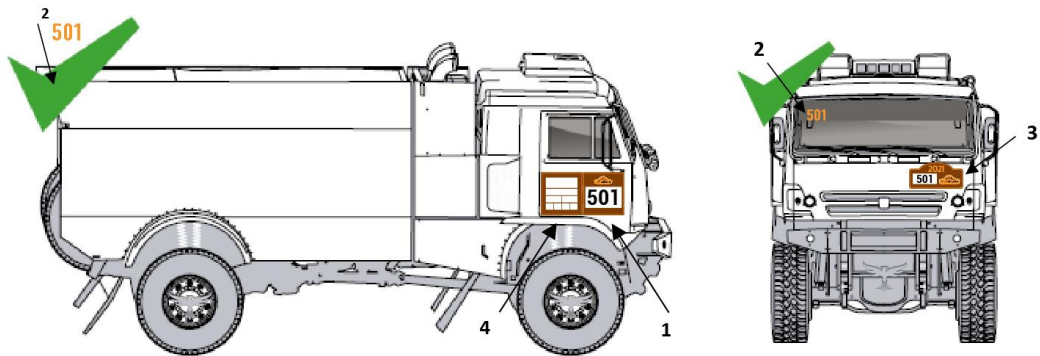

#### A7.5. Rally Plate and Number Panels Colours

In order to differentiate different groups, plates will be of different colours:

- the plates for racing vehicles will be white
- the plates for service vehicles will be yellow
- the plates for press vehicles will be green
- the plates for raid vehicles will be blue
- the plates for organisation vehicles will be red

#### A8. ADMINISTRATIVE CHECK

Competitors submitted their entry must be ready with all of the team members at the time stated in the programme or at the time they received from the organizers. Competitors failing to complete the administrative check will not be allowed to start.

Competitors and crews will receive a convocation stating the day and exact time at which they must present themselves at administrative checks.

Crews must present themselves without their vehicles, which must stay in the service park during administrative checks. Respecting these convocation times is compulsory. Failure to respect the convocation times will incur a penalty of **€50.00**.

##### A8.1. Documents to be Submitted During the Administrative Checks

- Signed copy of the entry form,
- Payment receipt,
- Sportive licences and start permissions,
- Drivers' licences,
- Copy of the vehicle's registration documents,
- Copy of the traffic insurance policy,
- If the vehicle is owned by someone else other than the drivers, car owner's authorization,
- List of the mechanics (1 Service Plate and 2 Mechanic badges will be handed).

**Competitors must present only valid documents.**

**If they fail to provide valid documents, they will not be allowed to start the event.**

**Originals must be presented; copies or modified documents would be refused.**

**Competitors attempting to present manipulated documents would be excluded from the event.**

#### A9. SCRUTINEERING

Vehicles entered to the event must be present in the scrutineering at the time stated in the programme.

On leaving administrative checks, competitors and crews will receive a convocation time for scrutineering. Right after exiting administrative checks, they must proceed to scrutineering.

Lateness for scrutineering will be sanctioned with a cash penalty of **€50.00**.

Competitors or their representative must present vehicle(s) and their documents along with drivers' FIA approved equipment. A team member can take the vehicle(s) to the parc ferme after the scrutineering.

Competitors who fail to complete scrutineering within the interval specified in the programme will not be allowed to start the event unless there is a force majeure reason accepted by the Clerk of the Course.

Competitor, whose force major is approved, must bring their vehicle to the Scrutineering no later than 1 hour before the Parc Ferme opening time. In this case, no lateness penalty to the Parck Ferme will be issued.

Competitor stating a force major must pay **€200.00** during administrative checks. If there's no payment accompanying the force

major, the competitor will not be given start.

Vehicles must present themselves at scrutineering with the mounting brackets, cables and aerials of the tracking equipment already fitted; ready to receive the Stella device. Stella must be connected directly to the battery (the presence of a fuse is compulsory) so that they function permanently, even when the engine is stopped or when the circuit breaker is activated.

Vehicles must be presented to scrutineering with plates and panels properly affixed on the vehicles according to articles **Refer to A7.4**. The good positioning of these plates / panels will be checked before scrutineering. In the event of a noted irregularity, competitors must bring their vehicle into compliance to pass the scrutineering.

Vehicles must be presented to scrutineering ready to race.

All vehicles which appear not to conform, or are not adapted to rally norms, during scrutineering may be given extra time (not exceeding a certain limit) with the decision of the Sporting Stewards. Even after this time if the vehicle can't complete the Scrutineering their start will be refused.

The technical control officer may refuse the start of vehicles that they do not appear safe because of modifications or excessive corrosion.

Competitors are responsible for the compliance of the modifications they made in their vehicles.

Competitors must fill the scrutineering form delivered at the Administrative Check. All the fields on the form dedicated for competitor should be filled and the form must be signed.

If, during the Scrutineering, it is determined by the scrutineers that a vehicle does not comply with the group it has declared, the competitor competes in the class that they belongs to and this change is indicated in the final start list.

The organization may setup unannounced scrutineering points during the event to determine whether the crews have changed or not and to check the compliance of the vehicles with the regulations.

Competitors and crews are responsible for ensuring the technical conformity of the vehicle during the event.

If the vehicles are sealed during the scrutineering, the competitors will ensure that these seals remain on the vehicle throughout the event. If a missing seal is detected during the event, relevant competitor will be disqualified from the event.

Organizer's compulsory advertising will be checked before the scrutineering. Vehicles in compliance with advertisements and door panels will proceed to the scrutineering. Vehicles which are not in compliance must fix those deficiencies before the scrutineering.

## **A9.1. Technical Specifications, Drivers' Equipment and Safety Devices**

### **A9.1.1. Technical Specifications for Group T-TH-SSV**

Vehicles entered as T1 - T2 - T3 - T4 - T5 must comply with the 2023 FIA Cross Country prescriptions and must have FIA Technical Passport.

**No homologation is required for ASN group vehicles.**

For these vehicles,

- It is mandatory to have headlights, taillights, direction indicators, etc to be in compliance with the provisions of the Turkish Traffic Law so they can be driven in liaisons.
- Flashing lights for dust must be in yellow colour and be fixed to the top of the car to the left or right side.
- There must be at least one 2 kg fire extinguisher. It must be securely fixed to the vehicle. Extinguishers must be full. Filling/production date must be recent.
- Fuel tank covers must be leakproof and fixed with a screw. Check valves should be installed on ventilation pipes. Protective sheet metal or something similar in function must be placed between fuel tank and drivers.
- Vehicles registered in T1 - T2 - ASN TH - T4 Group must be capable of covering at least 400 km. For vehicles registered in other groups, the capacity is 180 kilometres.
- Laminated windshield is mandatory for all cars to participate in event, except SSVs. SSVs' must have a polycarbonate lower spoiler in one third of the windshield area. At the pre-event scrutineering of the event, the windshield of the vehicle must be firmly attached. Drivers of vehicles whose windshields are broken or cracked during the event are required to wear a ski or enduro type goggles to continue the competition.
- Vehicles with factory/original side windows, foil is mandatory on the windows. It is obligatory to use net or solid polycarbonate material in vehicles without side windows.



- It is mandatory to use an FIA homologated racing seat with a homologation validity date of 2016 or newer.
- It is mandatory to use an FIA homologated seat belt with a homologation validity date of 2016 or newer. It is obligatory to have the cutter for the seat belts.
- FIA approved or TOSFED Technical Control Officer approved rollcage is mandatory.
- FIA approved rollbar pads must be installed on the pilot's and co-pilot's side (forehead, left-right side, back of the head).
- Pins are mandatory for the front and rear hood. The original locking systems must be removed.
- It is mandatory to use a gel or AGM type battery with an insulated positive terminal.
- Vehicles must be equipped with circuit breaker switches which can be internally and externally controlled to cut all electrical flow and stop the engine.
- There must be at least one towing hook on the front and rear bumpers of the vehicle, mounted on the chassis in a visible and easily accessible manner.
- Vehicles must have mudflaps. There must be mudflaps behind all wheels at a height that will touch the ground.

#### A9.1.1. Drivers' Equipment

All competitors are obliged to wear the equipment marked in **dark colour** throughout the event. Usage of the other equipment is recommended.

	Car - T5	SSV
<b>Helmet</b>	FIA (L-25) Homologated *1	FIA (L-25) Homologated *1
<b>Google</b>	Skiing - Enduro *2	Skiing - Enduro
<b>Glove</b>	Unrestricted	Unrestricted
<b>Overalls</b>	FIA (L-27) Homologated	FIA (L-27) Homologated
<b>Hans / Neck support</b>	FIA 8850-2010/8852-2002	FIA 8850-2010/8852-2002
<b>Underwears</b>	FIA Homologated	FIA Homologated
<b>Shoes</b>	Unrestricted	Unrestricted
<b>Rainjacket</b>	Unrestricted	Unrestricted

\*1 Driver's full name and blood type must be written in a single line at the nape of the helmet, with a line height of 2 cm, written in black on a white background and in Arial characters.

\*2 Drivers of vehicles with a broken or damaged windshield during the competition must wear ski or enduro type goggles to continue to compete.

#### A9.1.2. Safety Equipment

It is mandatory to have the safety equipment marked with dark colour in the table below. These equipment would be checked in the pre-event scrutineering and also randomly by the officials before the start of a selective section.

Equipment should be fixed in an accessible location inside the car for ease of use and controls. If the safety equipment is missing during the pre-start controls; the crew will be given a set time to fix the deficiencies. If they fail to do so their start would be refused.

SAFETY EQUIPMENT TABLE		
	Cars - SSV	T5 *4
Triangular Safety Reflector	2 Pieces	2 Piece
Seat Belt Cutter and Safety Hammer	2 Pieces	3 Pieces
Googles	2 Pieces	3 Pieces
Reflective Safety Vest	2 Pieces	3 Pieces
Flashing Torch (Safety Light)	1 Piece	1 Piece
Fire Blanket	2 Pieces	3 Pieces
Towing Belt / Strap *1	1 Piece	1 Piece
U Lock / Ringbolt	2 Pieces	2 Pieces
Energy Absorbing Blanket for the Towing Belt	1 Piece	1 Piece
Fire Extinguisher *2	1 Piece	2 Pieces
Lighter	2 Pieces	2 Pieces
Beverage (Alcohol free) / CamelBak	1.5 Litre / Person	1.5 Litre / Person
Flare	2 Pieces	2 Pieces
Portative Shovel	1 Piece	1 Piece
Head Lamp and Batteries	1 Piece	1 Piece
Survival Food Supplies	Min. 2000 Kcal	Min. 3000 Kcal
Clean Water Reserve	5 Litre	5 Litre
Compass	1 Piece	1 Piece

First Intervention Kit *3	1 Piece	1 Piece
---------------------------	---------	---------

\*1 Towing Belt / Strap must be flexible, with a minimum length of 4 meters, capable of pulling 3 times the weight of the vehicle. Usage of metal ropes are strictly prohibited.

\*2 Capacity of the fire extinguisher must be at least 2 kg. It must contain AFFF, FX G-TEC, Viro3, Powder or any other substance homologated by the FIA. All AFFF type extinguishers should be connected with manometer and easy-to-open type metal clamps. It is recommended to have a spare fire extinguisher fixed to the exterior of the vehicle.

\*3 Refer to the content of the first intervention kit **Annex 5. First Intervention Kit.**

\*4 For T5 class 3-person-crew is used as a basis. Number of equipment shall be matched with the total number of the crew.

## **A10. RUNNING OF THE EVENT**

Despite all the measures taken by the organization to close the selective sections with the support of governmental forces, TransAnatolia is an open road rally raid event. Competitors should be aware that they may encounter other vehicles inside the selective sections.

### **A10.1. Crews**

Crews in Group T1-T4, Group ASN and Group ASN SSV consists 2 people.

Group T5 can consist of 4 people depending on the capacity of the vehicle.

All members of the crew must hold a valid competition/racing licence. During the event any member of the crew can drive the vehicle.

If no competitor information is given while submitting the entry one of the crew member must obtain a licence to become the competitor, as well.

The first declared pilot assumes the entrant's responsibility when the latter is not on board the vehicle during the rally.

The withdrawal of a member of the crew or the admission of a third party on board (except transporting someone injured) will lead to the exclusion from the race.

During a Leg, transportation by land, water or by air of at least one member of the crew or the vehicle by the Organisers or by a third party will entail the disqualification from the leg for the crew concerned.

A truck crew will be composed of a driver and a co-driver minimum, of a driver and 3 co-drivers maximum, according to the registration certificate of the vehicle. They must all hold a valid license.

In the case of a crew composed of 3 or 4 members, only 2 crew members may have the truck driving license. In the case of retirement of one or two members of the crew, the vehicle may be allowed to compete, upon authorisation from the Clerk of the Course, as a function of the circumstances and only if the crew is still composed of 2 members, both possessing a heavy good vehicle license.

### **A10.2. Race Numbers, Start Intervals and Start Order**

#### **A10.2.1. Race Numbers**

Race numbers will be allocated depending on the groups.

- Group SSV 201 – 299
- Group T1-T2-T3-T4 301 – 399
- Group ASN 401 – 499
- Group T5 500 – 599

Race numbers will be attributed on the basis of the following criteria:

- Finishing positions in world renowned cross-country events
- Finishing positions in previous TransAnatolia Rally Raid, Rally Halikarnassos, Rally Antiphellos and Baja Anatolia events or in other international cross-country events
- Top 10 finishes in previous season's baja events
- Results from other motorsport events
- Sporting or media notoriety of a driver and/or team
- Drivers without experience

#### **A10.2.2. Start Intervals**

Motorbikes will start in front of other Groups. Group T, Group ASN and Class T5 order will be followed.

There will be

- 10 minutes interval between the last bike and the first Group T vehicle,
- 5 minutes interval between Group T1-T4 and Group ASN-SSV,
- 10 minutes interval between Group T5 and and Group ASN's last vehicle.

Bikes, Group T and ASN Group's first 10 competitors will have 2 minutes interval, the rest will have 1-minute interval.

### **A10.2.3. Start Order**

Start list for the Qualifying Stage would be based on the race numbers.

Start list for the next leg is prepared based on the previous leg's standings and can be altered by the Clerk of the Course if necessary.

Clerk of the Course can even alter the first leg's start list depending on a crew's vehicle or a driver's experience.

### **A10.3. Time Card**

At the start of each Leg, crews will be given a Time Card. It is obligatory to present the Time Card at all time control, start and stop points for the necessary procedures to be carried out.

A 10-minute time penalty will be given for each control point if the Time Card is lost or worn so it cannot be used.

It is forbidden to fill the parts other than the areas reserved for the use of the competitors on the Time Cards, except by the Marshals. Otherwise, the competitor / crew will receive penalties up to disqualification.

Time Cards must be handed at the end of the Leg on entrance to bivouac / service area.

Each crew is only responsible for their own Time Card.

### **A10.4. Start and Finish Ceremonies**

Participation in the ceremonies is obligatory for all competitors, except for those with valid force majeure reason duly accepted by the Stewards.

Drivers must wear racing overalls during the ceremony.

Time Cards will not be used in the pre-start holding area.

The instructions of the organizers and Marshals must be followed.

There will be a holding area before the ceremonial.

The exact schedule to enter the holding area will be published by means of a bulletin.

Any delay at the entrance of the holding area will result in the following penalties:

1 - 15 minutes      **€50.00**

16 - 30 minutes    **€100.00**

30 minutes or more will be reported to the Stewards.

Cars must be driven by one of the drivers or by a team representative to the ceremonial start holding area where any kind of service or re-fuelling is forbidden.

The holding area will be under vigilance. Access to the holding area is limited to team members and media representatives with appropriate identification.

### **A10.5. Qualifying Stage Start Procedure**

Before the Qualifying Stage, team members can bring the vehicle to the Pre-Start Holding Area. All competitors must bring their vehicles to this area at the latest 30 minutes before the start time of the first vehicle. Crews that are more than 30 minutes late will be reported to the Stewards.

Any competitor who, having started the Qualifying Stage fails to complete it as required by the regulations, will be given a place at the end of the Start List, in front of competitors who failed to start the stage. Order in between those will be based on **10.2.1**.

Clerk of the Course may even alter the first Start List based on the vehicle or experience.

### **A10.6. Finish Procedure**

At the end of the event, in order for a crew to be included in the general standings and in its group classification, it must not have been penalized for more than 3 days and finish the last stage on their own.

Crews getting a Leg Penalty on the last day of the event (8th Leg) are deemed to be Disqualified and are not included in the general standings or class standings.

### **A10.7. Liaison**

Liaisons are the connection stages between the camp and the selective section or two selective sections.

It is necessary to reach the next time control point at the target time.

Only competitors who complete their check-in before the Time Control point closes can start the stage.

Competitors who fail to enter the Selective Section must proceed to the next time control point.

For safety reasons, the route specified in the road book must be followed. If a competitor is to leave the road book for valid reasons, they must obtain approval from the safety officer or the Clerk of the Course. If it is determined by the satellite tracking system that the route is abandoned without permission, a penalty is applied.

#### **A10.8. Time Control Point Procedures**

- All time controls, passage controls, selective section start and re-grouping areas will be clearly marked with rally signs in accordance with FIA standards.
- Crews must present their time cards before their target check-in time. Example: If a competitor whose target check-in time is 17:58 checks-in between 17:58:00 and 17:58:59, they will be deemed to have checked-in on time.
- Maximum lateness to a time control point cannot exceed 30 minutes. A crew who is more than 30 minutes late will not be allowed to start.
- **Early check-in to service area (re-grouping) is permitted.** Maximum lateness to service park time control point cannot exceed 30 minutes.
- For the differences between the target time and real time the following penalties will be applied:
  - **10 seconds** penalty for each minute for late arrivals.  
Lateness cannot exceed **30 minutes**. Start will be refused for the Crews exceeding the limit.
  - **60 seconds** penalty for each minute for early arrivals.
- It is forbidden to stop between Yellow FF board and the Stop point. In case of violation, penalties will be applied.
- At the Selective Section Stop points crews must have their FF times inscribed to their time cards.

#### **A10.9. Selective Sections**

Speed test in real time.

Crews fail to reach the flying finish of the selective section within the target time will be disqualified from the respective selective section.

##### **A10.9.1. Selective Section Start Procedures**

Competitor must present the time card to the marshall on time control point on time.

TC marshall adds 3 minutes to the check-in time and directs the crew to the Start point.

Crew must be ready on the Start line with all the safety measures (seat belts fastened, helmets on, satellite trackin on, etc) are taken.

In addition, the continuity of these measures should be ensured while running the stage.

A yellow point is displayed 1 minute prior to the start.

First red light appears 30 seconds to the start.

When there are 5 seconds to the start 1 red light appears on the device in each second.

Once the red lights are off the crew can start.

In case of any malfunction or deficiency that may occur in the starting equipment, the start marshal will start the crew manually.

Start marshal will use a chronometer to notify the crew 1 minute before the start.

Start marshal will notify the crew 30 seconds before the start to keep the doors shut and close the windows.

Start marshal will display one arm; holding their hand closed in the form of a fist 10 seconds before the start.

Start marshal will open his fingers starting from 5 seconds before the start. They will open their fingers and show every remaining second with the fingers.

At the start moment, he will raise his arm and give the command to depart.

For false start a penalty will be applied

- 1st infringement : 1 Minute
- 2nd infringement : 3 Minutes
- 3rd infringement : 10 Minutes
- Other infringement : Decision of the Stewards

Competitors starting the stage must leave the starting area, which ends with the Beige Diagonal sign, within 1 minute. Otherwise, a penalty will be applied.

Please refer to **Annex 7 Control Point Signs** for the signage.

##### **A10.9.2. Timing in Selective Sections**

Flying finish points will be setup at selective sections and time recording will be carried out with photocells at these points.

In case the photocell equipment is not working, time will be manually recorded with a stopwatch.

Time recorded at the flying finish point will be noted on the competitor's time card at the stop point.

The time will be in the form of hours, minutes and seconds. Precision will be in seconds.

Please refer to **Annex 7 Control Point Signs** for the signage.

#### **A10.10. Service Park / Bivouac**

Early check-in to service in TC's is permitted.

A **60-minute penalty** is added to the relevant leg's time for the competitors who are more than **30 minutes** late to the service park entrance.

Teams with the biggest number of vehicles will be placed on the bivouac by organizers. They will have to comply with the rules and instructions of organizers.

After having checked in at the time control at the end of the leg, competitors or team members cannot take race vehicles out of the bivouac. Only with the consent of the Clerk of the Course in a radius of **30 kilometres** of the bivouac race vehicle can be taken out for testing. During these tests the tracking system must be switched on, on pain of penalties to be decided upon by the Stewards. All tests must be done outside the route of selective sections.

It is forbidden to get assistance outside the Service Area, except at the places determined by the organization during liaisons. Violation of this rule will be penalized with a leg penalty.

It is obligatory to use floor coverings under the vehicles. These covering should overflow the vehicle's dimensions 1 meter in all directions. Covering should be at least in the dimensions of 3m x 5m.

Competitors can change assistance personnel, provided that they notify the organization.

It is mandatory for assistance personnel to wear a badge. Personnel with a service badge will only be able to work on the vehicle inside the Service Area. They cannot work on the vehicle in selective sections and road sections.

Only people with valid badges/bracelets will be allowed.  
Refer to **A10.14.3.** for speed limitations inside the service area.

Please refer to **Annex 7 Control Point Signs** for the signage.

#### **A10.10.1. Service Area / Bivouac Locations**

TBA

#### **A10.10.2. Assistance Crews and People Accompanied by Them**

Competitors are jointly and individually responsible for their assistance crews and accompanying persons.

In case of violation of the Supplementary Regulations and the use of prohibited equipment – regardless of the direct or indirect effects of this incident on the results or on the sportive operation – the Stewards will examine the incident and may impose penalties up to exclusion to the competitors directly or indirectly involved in this incident.

Competitors, team members and assistance personnel must wear wristbands and badges so they can be present in all the areas as part of the event, including the service area. If requested, team members must show their wristbands.

Crews that receive support from people who are not registered and do not have wristbands are fined from **€ 200.00** to disqualification with the decision of the Stewards.

#### **A10.11. Rescue Intervention and Towing**

If the vehicle cannot move on its own, the consequences that may arise from the actions to take place in are as follows.

- For the crews still competing, no penalty is applied for pushing / pulling operations on the liaisons by other vehicles, rescue vehicles or assistance teams.
- Pushing and pulling operations on the route and in a way that will not disrupt the flow of the stage by the competitors who continue to race in the special stages are not penalized. There is no penalty or time improvement for the team performing the pushing or pulling operation.
- **In Selective Sections, all the operations carried out by the Rescues will be penalized with the disqualification from the selective section.** For the crew which received Rescue assistance the relevant stage is deemed to be over. The crew can proceed to a time control point where they can reach within the target time or they can proceed to the service park / bivouac.

#### **A10.12. Refuelling**

##### **A10.12.1. Refuelling Zones**

For safety reasons refuelling can only be carried out in the specified areas below.

- In the area designated for refuelling inside the service park/bivouac.
- For groups **T3-T4 and ASN SSV** in refuelling zones set up by organisers inside the Selective Sections. They should have at least 180 km range.
- For groups **T1-T2 and ASN Classes** refuelling is only allowed on the zones set up by organisers inside the Selective Sections provided that fuel is supplied by their assistance team and all the safety measures should be taken. It is advised that they would have at least 400 km range.
- Along liaisons on commercial stations with safety equipment in operation.

(Organizers will mark approved petrol stations to the road book.)

Please refer to **Annex 7 Control Point Signs** for the signage.

### A10.12.2. Points to be Considered During Refuelling

Fuel offered in the selective section will be delivered in exchange of the fuel vouchers purchased during administrative check or later at the service park. Cash or post payment isn't allowed.

In every refuelling point the engine must be stopped and the car on its wheels.

Drivers should stay outside the car during refuelling.

Competitor must check that there are fire extinguishers before they start refuelling. During refuelling, the responsibility belongs to the competitor.

The fuel tank replacement will not be considered as a refuelling.

Parc ferme rules apply at refuelling points, except for refuelling operations.

Any further intervention will be considered as a violation of servicing (assistance).

### IMPORTANT WARNING!

ONLY standard METAL JERRYCANS may be used for refuelling.

Usage of all other materials is strictly prohibited.

### A10.12.3. Refuelling Points to be Setup in Selective Sections

Metal Jerrycan



Plastic Bottles



Quick Fill Can



On entry and exit to refuelling points there will be signboards.

There will be a 20 minute neutralization for all competitors.

Speed limit in the refuelling point is 30 km/h. The road book will contain SZ/FZ squares.

Exceeding the speed limit in the refuelling area will be considered as exceeding the speed limit in the service park. **Check A10.14.3**

**Teams that fail to enter the neutralization area set-up for the refuelling will be disqualified from the respective Selective Section.**

Please refer to **Annex 7 Control Point Signs** for the signage.

### A10.13. Tyres

Tires and their tread depths must concordant with the selective section terrain. Mud flaps are obligatory. There must be mud flaps high enough to touch the ground.

### A10.14. Speed Zones

#### A10.14.1. Speed Limits for Liaisons

SPEED LIMITS IN THE REPUBLIC OF TURKEY				
VEHICLE TYPE	RESIDENTIAL AREA (km/s)	OUT OF RESIDENTIAL AREA		HUGHWAY (km/s)
		TWO WAY ROAD (km/s)	DUAL CARRIAGEWAY (km/s)	
Car (M1) (M1G)	50	90	110	120
Minibus (M2)	50	80	90	100
Pick-up (N1) (N1G)	50	80	85	95
Truck (N2) (N3)	50	80	85	95
Panelvan (N1)	50	85	100	110
Motobike (L3)	50	80	90	100
Bicycle	30	45	45	Not admitted

Towing	20	20	30	40
--------	----	----	----	----

Legal speed limits apply on liaison and traffic rules must be followed.

For speed violations exceeding the 10% tolerance of the legal speed limits of the highways, the following penal sanctions are applied regardless of whether they are in the defined speed limit zone or not.

Speed controls may be carried out to check conformity with the national traffic rules. In addition to that under some special cases speed restriction may be applied. These limitations will be checked randomly via GPS. Exceptions will be published in the bulletin and/or road book.

The start of the speed control zone is indicated as "SZ" and end of the speed control zone is indicated as "DZ".

The tolerance zone is set 90 metres around these points.

Any impulse recorded inside the speed zone will be penalized. For infringements

- between 1-20 km/h above the limit **30 seconds** and **€25.00**,
- between 21-40 km/h above the limit **1 minute** and **€50.00**,
- 40 km/h above the limit **10 minutes** and **€100.00**

will be fined.

The speed limit will appear on competitors' GPS screens, once the entry waypoint is validated.

The competitors can in no way claim not to know either the entrance or exit of the zone. If GPS records are missing and speed limit violations are detected, penalties will be applied.

In the event of repeating offenses, the case will be regarded as unsporting behaviour and will be reported to the Stewards. Penalties up to the disqualification from the leg may be applied.

#### **A10.14.2. Speed Restriction in Selective Sections**

By considering the protection level that can be ensured by the safety equipment maximum speeds for selective sections are set.

<b>GROUP</b>	<b>SPEED LIMIT</b>
T1	170 km/s
T2	170 km/s
T3	135 km/s
T4	125 km/s
T5	140 km/s
ASN TH	170 km/s
ASN SSV	135 km/s
ASN Trucks	140 km/s

It is compulsory to obey the speed limits inside the selective sections. In addition to these limits extra restrictions may be applied for the sections passing through residential areas. Crews must comply with these limits. Speed control zones will be indicated in the road book.

Speed control checks will be carried out for speed control zones without prior notice. In addition to that random checks will be carried out to determine compliance with the speed limitations. If GPS records are missing and speed limit violations are detected, penalties will be applied. Entrance to speed control zone is marked as "SZ" and the exit of the speed control zone is marked as "DZ". The tolerance zone is set 90 metres around these points.

Any impulse recorded inside the speed zone will be penalized. For infringements

- between 1-15 km/h above the limit **1 minute** and **€25.00**,
- between 16-40 km/h above the limit **2 minutes** and **€50.00**,
- 40 km/h above the limit **10 minutes** and **€100.00** (first infringement)  
**20 minutes** and **€150.00** (second infringement)  
**20 minutes** and **€150.00** (second infringement)

will be fined.

The speed limit will appear on competitors' GPS screens, once the entry waypoint is validated.

The competitors can in no way claim not to know either the entrance or exit of the zone. Between the entry and exit points, regardless of the route followed, competitor's speed must have decreased and reach the limits specified in the road book. If GPS records are missing and speed limit violations are detected, penalties will be applied.

In the event of repeating offenses, the case will be regarded as unsporting behaviour and will be reported to the Stewards. Penalties up to the disqualification from the leg may be applied.

#### **A10.14.3. Speed Limitation on Bivouac and Service Park**

Pedestrians have permanent priority within the bivouac/service area. The speed limit is **30 km/h**. Competitors found to be

exceeding the speed limit or driving dangerously will be fined up to €1,000.00.

#### A10.14.1. Way Points

Competitors must pass through all Way Points (WP) in order.

For each WP skipped or not validated, a **15-minute** time penalty is added to the competitor's selective section time.

A competitor who skips more than 25% of the total number of WP's in a selective section will be disqualified from the respective selective section. A competitor who skips more than 40% of the total number of WP's during a leg will be disqualified from the respective leg.

The competitor who is lost in a selective section can move in the opposite direction without staying in the racing line, up to the previous road book square, to find their direction and way.

**The distance travelled in the reverse direction cannot exceed 2 km. The maximum speed in the opposite direction shall not exceed 30 km/h.**

Under these conditions, no penalty will be applied unless it endangers the competition.

A competitor who violates any of these conditions will be disqualified from the selective section.

In cases that are unsportsmanlike or that may pose a danger, the Stewards may expel the relevant competitor from the competition.

#### A10.15. Penalties

##### A10.15.1. Leg Penalties

It is the penalty given to the competitors to keep them in the competition in cases where they cannot be included in the classification due to a skipped time control or not validated time control point within the target time or failing to complete the selective section within the 'Target Time' specified in the itinerary. During the event, a crew can be penalized for a maximum of 3 days, excluding the final day. Competitors who receive a leg penalty for more than 3 days or on the last day are not included in the general classification.

Competitors who receive a leg penalty (for the relevant leg) are given a 3-hour time penalty, this cannot be more than once a day.

The crew can proceed to a time control point where they can reach within the target time or they can proceed to the service park / bivouac.

##### A10.15.2. Selective Section Penalties

It is the penalty given to the competitors who did not start a selective section or did not finish a selective section within the target time or in a way required by the rules.

There is no lateness tolerance for the target time.

To the competitor who is disqualified from the stage is given a time (penalty) by calculating.

Target Time + Unvalidated Way Points

In addition to the above penalties, a **2-hour** time penalty is given to the competitors who failed to start the selective section.

#### Examples.

	SS 1	SS 2
Target Time:	00h45m	01h30m
Number of Way Points:	8	12

#### Scenario 1

Selective Section 1 – Disqualification from the Selective Section (Started– Mechanical Failure – Unvalidated WP: 4)

Selective Section 2 – 01h22m13s

#### Results

Leg Penalty : 03h00m  
[Target Time + (Unvalidated WP x 15 minutes)]  
Selective Section 1 : 01h45m [00h45m + (4 x 00h15m = 01h00m)]  
Selective Section 2 : 01h22m13s  
Leg Result : 06h07m13s

#### Scenario 2

Selective Section 1 – Disqualification from the Selective Section (Started– Rescue Intervention – Unvalidated WP: 2)

Selective Section 2 – Did not Start

#### Results



Leg Penalty	: 03h00m	[Target Time + (Unvalidated WP x 15 minutes)]
Selective Section 1	: 01h15m	[00h45m + (2 x 00h15m = 00h30m)]
Selective Section 2	: 06h30m	[Target Time + (Unvalidated WP x 15 minutes) + Did not Start]
Leg Result	: 10h45m13s	[01h30m + (12 x 00h15m = 03h00m) + 02h00m]

### A10.15.3. Payments of Cash Penalties

Fines issued to competitors must be paid,

- To the Competitors Relations Officer or to the Clerk of the Course,
- In Euro, Dollar or Turkish Lira,
- Within 48 hours from the date of notification to the competitor,
- Within 24 hours from the date of notification to the competitor, for the 7th Leg,
- Until the prize giving time on the same day, for the 8th Leg.

### A10.17. Selective Section Cancellations

In case of cancellation of a selective section that has not yet been run, the next selective section, if any, will be run, otherwise the leg will end in the bivouac. Cancellation information will be communicated by competitors' relations officer, where possible, otherwise with the instruction of the Clerk of the Course at the first time control point.

If there is a blockage or closure in a selective section that has started to be run,

If fifty percent or more of the competitors in general classification who started the previous stage finishes the selective section in question, the competitors who cannot finish the selective section are given the worst time among the finishers.

If less than fifty percent of the competitors in general classification who started in the previous stage finishes the stage in question, the Clerk of the Course evaluates the situation and makes a decision.

### A2.2. Tracking system

Stella is a system that enables vehicles to be tracked via satellite and is compulsory for all racing vehicles. For detailed information and operating procedures, **see Appendix 4.**

Throughout the event crews are responsible for the correct functioning of their device. It must be functioning and stay permanently connected, with power cables and aerial connected throughout the length of each leg.

Any incident caused by the crew (loss, destruction, being switched off etc.) and / or all attempts of a fraudulent nature or manipulation will result in penalties, up to disqualification, to be decided upon by the Stewards. **Any competitor whose device does not work leg will be refused the start.**

They will have 30 minutes to comply without incurring penalties. Beyond this time, penalties will be applied.

### A2.3. Emergencies

<b>ORGANİZASYONUN ACİL DURUM TELEFONU:</b>	<b>+90 538 441 59 04</b>	<b>(TÜRKÇE)</b>
<b>EMERGENCY NUMBER OF THE ORGANISATION:</b>	<b>+90 538 441 58 20</b>	<b>(ENGLISH, ITALIANO)</b>
<b>EMERGENCY NUMBER OF THE ORGANISATION:</b>	<b>+90 536 311 82 64</b>	<b>(FRENCH)</b>

In case of an emergency first an alert should be sent via Stella and if required **112** or **911** must be called.

Emergency phone number is written on the bracelet. Failure to wear this bracelet will result in a penalty of 10% of the entry fee.

In the case where the bracelet becomes damaged the person must request a replacement from the competitors' relations officer, in exchange for the damaged item.

#### A2.3.1. Incident

In the case of an accident-causing injuries, the crew must immediately contact the HQ by any means and as soon as possible, so that the latter may send the required mean of intervention as quickly as possible.

**If one of the team members is OK and can move, they should press red and blue buttons simultaneously to inform the HQ and the competitors around.**

If the vehicle represents a danger to other competitors or, to make safe the area of the accident, a crew member must, after having pressed the red button of the GPS, place a red reflective triangle in an appropriate position, at least 50 metres before the vehicle, so as to warn other competitors.

**All crews failing to respect this rule are liable to penalties at the discretion of the Stewards.**

Any incident involving Competitors could be investigated by the Stewards.

**Depending on the circumstances, penalties up to disqualification may applied.**

Any incident between Competitors could be investigated by the Officials and the Organisers.

If it is proven that this incident is considered as a "Race Incident", the liability of the crews/competitors and of the organisers shall not be involved.

In the event of an accident, if only visual contact can be established, the crew who had an accident; must notify any officials or competitors approaching them of their request for assistance or their well-being as shown below.

In case the crew who had an accident moves away from the vehicle, the OK/SOS sign on their vehicle must be placed on the car that would be visible from the direction of arrival according to the road book. It must be fixed in such a way that it wouldn't change



position and shape with factors like wind, etc.

**Crews failing to respect the article A10.19.1 are liable to penalties at the discretion of the Stewards with respect to the provisions of the International Sporting Code.**

#### **A10.19.2. Help to Injured**

It must be remembered that ethics requires that a crew which sees that an accident has occurred stop to provide assistance in the most appropriate manner until the rescue service arrives.

Also, it must be remembered that major means are implemented to shorten the intervention times.

**Any crew which witnesses an accident placing another competitor in physical danger must in the following order:**

- stop,
- press red and blue button for 1 second to activate the alarm function of the Stella, so as to inform other competitors arriving on spot,
- give the first aid (if they're capable) to the crew members and get information on their condition,
- call the HQ to report the situation,
- place a red reflective triangle in an appropriate position, at least 50 metres before the vehicle, so as to warn
- other competitors,
- wait for the rescue service or another crew to arrive,
- press the green button on their Stella, to signal that they are leaving the scene.

If it is impossible to communicate with the HQ via phone, the crew arriving at the scene of the accident must activate the Stella of the crashed vehicle by simultaneously pressing blue and red buttons for 1 second. If this cannot be done, they should end the signal from their own device.

**Under normal conditions erroneous alerts result disqualification but it is not applied if the alarm is activated for reporting another crew's accident.**

The total stopping time between the 2 signals (red+blue for emergency and green on restarting) will be subtracted from the time taken to cover the selective section, but only for the first two crews to stop at the scene of the accident, upon the request of the competitor or of its official representant to the Clerk of the Course, made within a maximum of 30 minutes after finishing the day's leg.

The total stopping time can be checked and validated by the GPS tracking system.

**Crews failing to respect the article A10.19.2 are liable to penalties at the discretion of the Stewards with respect to the provisions of the International Sporting Code.**

#### **A10.19.3. Accident on a Road Section**

In the case of an accident with a third party on a road section, causing injuries or material damage, the crew must immediately contact the HQ by any means and as soon as possible, so that the latter may coordinate the required mean of intervention as quickly as possible by directing the crew.

### **A11. RESTRICTIONS AND OBLIGATIONS**

#### **A11.1. Devices Allowed in the Cockpit**

##### **A11.1.1. Phones**

- GSM Phones
- Smart Phones
- Iridium Satellite Phons

For obvious safety reasons, the phone numbers of the phones boarded on the vehicle must be given to the organisers at administrative checks.

On selective sections, only in case of problems crews must inform the HQ of their situation via Stella.

Telephones may be used, only outside of the vehicle, with the vehicle stopped, to signal a retirement, an accident or a breakdown.

**Apart from the above-mentioned point, telephones may in no way remain switched on during the selective sections.**

Spot checks may be carried out. **Any infringement will lead to penalties which may go as far as disqualification.**

#### **A11.1.2. Onboard Cameras**

Any plan to use an onboard camera will be subject to a written request, sent to the organization Head of Media before the end of the administrative checks.

Competitors are obliged to accept the fitting of a kit (power cables and mounting bracket) and the fitting of onboard camera (+ sound) during the rally. These systems will be installed temporarily in vehicles as required by the organisers, by the organisation's supplier. **All refusal will result in the start being refused.** The camera must function and remain permanently connected throughout the stage.

Onboard cameras equipped with a GPS system are prohibited.

**For security reasons, usage of helmet cameras or helmet-mounted action cameras are prohibited in all classes and groups.**

**Penalties up to disqualification may apply for violations of the use of cameras and recordings.**

#### **A11.2. Devices not Allowed Onboard**

- Touch pads / digital tablets
- 3<sup>rd</sup> party digital road book or navigational devices
- GPS watches
- Any other instrument connected to the internet
- All types of storage devices

**Anything that is not explicitly allowed is forbidden.**

No permanent aerial, 'hands-free' kit, fixed installation or pre-wiring is authorised in the vehicle, except for the GPS tracking system and on-board cameras supplied by the organisation. The installation and use of a removable antenna (Iridium and/or GPS) is strictly prohibited.

During selective sections no transmissions (to or from the vehicle) of the type SMS, MMS, or of data is authorised. All equipment (data cables, infra-red, Blue Tooth, Wi-Fi or others) is forbidden.

**All infractions will result in penalties up to and including disqualification.**

#### **A11.3. Prohibition**

It is strictly forbidden to carry and possess firearms during the organization. In case of violation of this rule, the relevant crew is expelled from the competition.

#### **A11.4. Responsibilities**

All competitors, crews and guests and assistance personnel involved in the organization together with these competitors agree in advance to comply with the provisions of the supplementary regulations, the instructions and warnings of the officials, upon submitting their entry for the event.

Competitors and crews must behave with respect and courtesy both on the route and with regard to: the local population, other competitors, crews, and officials.

Any impoliteness which is proven will be subject to a penalty of **€500.00** to disqualification from the event.

#### **A11.4.1. Respecting the Environment**

**RESPECTING THE ENVIRONMENT IS A PRIORITY!**

##### **A11.4.1.1. Waste Management**

It is forbidden to leave wheels or punctured or damaged tyres on the itinerary of the route. Any competitor caught disobeying this rule will be get a penalty of 100.00 € per tyre and/or wheel. Repeat offending will result in a 250.00 € penalty, but it may lead to disqualification.

In Bivouacs and Service Areas it is obligatory to have ground coverings under the vehicles. Any competitor caught disobeying this rule will be get a penalty of 100.00 € per tyre and/or wheel. Repeat offending will result in a 250.00 € penalty, but it may lead to disqualification.

There will be barrels in the Bivouacs and Service Areas to collect the waste liquids (engine oil and all kinds of liquids and gels used in mechanical components) coming out of the vehicles. Waste liquids must be poured into these barrels. Any competitor caught disobeying this rule will be get a penalty of 100.00 € per tyre and/or wheel. Repeat offending will result in a 250.00 € penalty, but it may lead to disqualification.

It is forbidden to smoke and throw away rubbish/stub on the itinerary of the route and especially on the pre-start areas, Starts and Finishes of selective sections. Any infringement will lead to a penalty of 50.00 €. Repeat offending will result in a 100.00 € penalty, but it may lead to disqualification.

It is forbidden to throw rubbish and light a fire outside the designated areas on the bivouac / service park. Any rubbish, waste oil etc. dumped on any other place than the ones planned by the organisers or lighting a fire without the permission from the bivouac officer will lead to a penalty of 50.00 €. Repeat offending will result in a 250.00 € penalty, but it may lead to disqualification.

#### **A11.4.1.2. Responsibilities for the Environmental Factors**

In agricultural or forest areas, populated zones or zones that are sensitive from an environmental or safety standpoint, the itinerary and all the boxes of the road book must be scrupulously followed. It is forbidden to 'cut' corners by crossing fields, forests, orchards or marshes. First infringement will be fined with **500.00 €** in addition to **15 minutes**. Repeating offenses may lead to penalties up to and including disqualification. In the event of damage to the cultivated land, fields, trees, etc. the offending competitor will be held responsible for all damages.

To respect the crossed areas, it is forbidden to destroy the fences' gates and barriers located along the route. First infringement will be fined with **500.00 €** in addition to **15 minutes**. Repeating offenses may lead to penalties up to and including disqualification. In case of deterioration of land, fences, barriers etc., the offending competitor shall be liable for all the induced costs.

The maximum allowable exhaust noise limit is 120 dB for Groups B and Q, and 103 dB for Groups T and ASN Classes. Vehicles that make more noise than allowed are not allowed to start. During the Scrutineering the noise level will be measured with a sonometer held at a 45° angle 50 cm away from the exhaust of the vehicle engine running at 3500rpm. Crews must ensure that the silencer is present, and the sound level does not exceed the limit during the event. At any stage of the competition, the exhaust noise level can be measured and penalties up to disqualification can be applied in case of non-compliance.

### **A12. PROTESTS - APPEALS**

Protests must be raised in written form via competitors' relations officer accompanied by the fee of **£3,410.00** in cash.

If the protest requires the dismantling and re-assembly of a clearly defined part of the car (engine, transmission, steering, braking system, electrical installation, bodywork, etc.), the claimant must pay an additional deposit of **€ 500**.

For the issues couldn't be resolved throughout the event the matter can be escalated to the appeal in front of the Turkish Automobile Sports Federation. The cost for a national (TOSFED) appeal is **£24,200.00**

### **A13. PRIZES AND PRIZE GIVING**

#### **A13.1. Prizes**

A trophy will be given to each crew member of the  
top 3 finishers in the general standings  
top 3 finishers in the generated standings  
top 3 finishers in respective classes

Winner of the prologue will be awarded with a trophy.

The awards provided by the sponsors will be presented at the prize giving ceremony as stipulated by the sponsoring organization.

#### **A13.2. Specifics for the Prize Giving Ceremony**

The attendance at the finish ceremony and prize giving is compulsory for all crews and crew members must wear their approved overalls or their team jerseys.

During the prize giving ceremony, it is forbidden to invite anyone to the podium other than the relevant crews and the people who will present the awards.

It is forbidden for competitors and drivers to make out-of-competition statements during the prize giving ceremony.

The awards of the drivers who do not attend the ceremony due to an excuse are delivered to someone appointed by the competitor, outside the podium. Otherwise, the organizers will ship the prizes of the crew to the address specified in the registration form

On the ceremony, first finishers will be presented their medals and then podium finishers will be presented their trophies.

**A13.3. Place and Time of the Prize Giving Ceremony**

Prize giving ceremony will take place in Izmir's podium area on 9 September 2023 at 17:00.

**Annex 1 Itinerary**

Please refer to Sportity App for the latest version of the itinerary.

## Annex 2 Information about Competitors Relationship Officer



Adı Soyadı / *Name*  
Elif TANCA

Lisan / *Languages*  
Türkçe  
English  
Italiano

Telefon / *Mobile Phone*  
+90 538 441 59 04

Mail Adresi / *E-mail adress*  
elif.tanca@transanatolia.com



Adı Soyadı / *Name*  
Yiğit TOP

Lisan / *Languages*  
Français

Telefon / *Mobile Phone*  
+90 536 311 82 64

Tarih / <i>Date</i>	Saat / <i>Time (GMT + 3)</i>	Konum / <i>Location</i>
01 July - 20 September 2023	10:00 - 18:00	p: +90 538 441 59 04
	Her zaman / <i>Anytime</i>	m: elif.tanca@transanatolia.com
2 September 2023	08:00 - 09:00	İdari Kontrol / <i>Administrative Checks</i>
	09:00 - 10:00	Teknik Kontrol / <i>Scrutineering</i>
2 September 2023	18:00	Seremonik Start / <i>Ceremonial Start</i>
3-8 September 2023	06:00 - 09:00	Servis Alanı / <i>Service Area</i>
	09:00 - 18:00	HQ - Mobil
	18:00 - 22:00	HQ - Bivouac
	07:00 - 10:00	Servis Alanı / <i>Service Area</i>

9 September 2023	10:00 - 14:00	HQ - Mobil
	15:00	Finish Seremonisi / <i>Finish Ceremony</i>
10 - 17 September 2023	12:00 - 18:00	p: +90 538 441 59 04 m: elif.tanca@transanatolia.com
18 September 2023 and afterwards	10:00 - 17:00	m: elif.tanca@transanatolia.com

### Annex 3 Table of Penalties

#	REASON	RELATED ARTICLE	CONDITION	PENALTY			Up to Disqualification
				Cash	Time	Other	
1	Missing the pre-event briefing (at least one of the crew members)	A3.2	İhlal	€ 100			
2	Missing the end of the leg briefings (at least one of the crew members)	A3.2	Each Infringement	€ 25		Uyarı	X
3	Missing or misappliance of number panel or advertising	A7.2.1	Each Infringement	%10 Entry Fee			
4	Missing name, flag and blood type info on the front wing / door	A7.2.1	Each Infringement	%10 Entry Fee			
5	Missing or misappliance of advertising	A7.3.1	First Infringement Repeating Offenses	%10 Entry Fee %20 Entry Fee			
6	Missing the administrative check appointment	A8	First Infringement Zaman Aşımı	€ 50		Start Alamaz	
7	Presenting null and void / copied document on administrative check	A8.1				Start Alamaz	
8	Missing the scrutineering appointment	A9	First Infringement Time Out	€ 50		Start Alamaz	
9	Declaring force majeure (if it is validated)	A9		€ 200			
10	Withdrawal of a crew member of accompanying a non crew member onboard	A10.1				Yarış İhraç	
11	Lost or worn time card	A10.3	Each Infringement		10 Minute		
12	Being late to pre-ceremony holding area	A10.4	1-15 Minutes 16-30 Minutes 30+ Minutes	€ 50 € 100		SKK Sevk	X
13	Leaving the route without permission from the Clerk of the Course or the Chief Safety Officer	A10.7	Each Infringement Repeating Offenses	€ 100		SKK Sevk	X
14	Late check-in to TC	A10.8	Each Minute After 30 Minutes		10 Saniye	Etap İhraç	
15	Early check-in to TC	A10.8	Each Minute		1 Minute		
16	Stopping between Yellow FF sign and STOP point	A10.8	First Offense Second Offense Third Offense		1 Minute 3 Minute	SKK Sevk	
17	Skipping the Finish (STOP) procedures	A10.8				Etap İhraç	
18	Unfastened seat belts or helmets inside a selective section while the vehicle is moving	A10.9.1	First Offense Second Offense Third Offense	€ 100 € 250		SKK Sevk	X



#	REASON	RELATED ARTICLE	CONDITION	PENALTY			Up to Disqualification
				Cash	Time	Other	
19	False start	A10.9.1	First Offense Second Offense Third Offense Repeating Offenses		1 Minute 3 Minutes 10 Minutes	Reported to the Stewards	
20	Not leaving the start area (beigne sign board) in 1 minute	A10.9.1	For the Second Minute  After 2 Minutes		1 Minute	DSQ from the SS	
21	Late check-in to Service Park (Bivouac)	A10.10	Up to 30 Minutes After 30 Minutes		10 Seconds for each Minute  60 Minute		
22	Getting assistance out of the service park, in a road section in an area which is not designated by the organization	A10.10				DSQ from the Leg	
23	Getting mechanical assistance from people who doesn't have wristband and not registered as assistance personnel	A10.10.2	Each Infringement	€ 200			X
24	Rescue intervention in a selective section	A10.11				DSQ from the SS	
25	Missing the neutralization zone set-up for refuelling	A10.12.3				DSQ from the SS	
26	Missing GPS records for speed restriction zones	A10.14	Each Infringement  Repeating Offense		30 Minutes	Reported to the Stewards	X
27	Exceeding speed limit in a road section (for each pulse)	A10.14.1	Between 1-20 km/h Between 21-40 km/h More than 40 km/h Repeating Offenses	€ 25 € 50 € 100	30 Seconds 1 Minute 10 Minutes	Reported to the Stewards	
28	Exceeding the limit in speed restriction zone in a selective section (for each pulse)	A10.14.2	Between 1-15 km/h Between 16-40 km/h After 40 km/h; First Offence Second Offence Third Offence	€ 25 € 50  € 100 € 150 € 200	1 Minute 2 Minutes  10 Minutes 20 Minutes 40 Minutes		
29	Not obeying the speed limit (30 km/h) in service park / bivouac	A10.14.3	Each Infringement	€ 1.000'ya varan			X
30	Missing Way Point (WP)	A10.15	For Each WP		15 Minutes		
31	Not starting a selective section	A10.16.2	For Each Missing Start		2 Hours		
32	Failing to complete the Qualifying Stage or not starting	A10.2.3	Failing to complete    Failing to start		1.5 times stage's estimated time  At least one hour or 2 times stage's estimated time		
33	Missing GPS records	A10.18				Reported to the Stewards	X
34	Violations related to the use of cameras and recorders	A11.1.2				Reported to the Stewards	X

#	REASON	RELATED ARTICLE	CONDITION	PENALTY			Up to Disqualification
				Cash	Time	Other	
35	Having not allowed devices onboard	A11.2				Reported to the Stewards	X
36	Carrying and possession of firearms during the event	A11.3				DSQ	
37	Rude behavior towards population in the area, other competitors and officials	A11.4		€ 500			X
38	Leaving wheels or punctured or damaged tyres on the route (per tyre / wheel)	A11.4.1.1	First Infringement	€ 100			X
			Repeating Offenses	€ 250			
39	Missing ground coverings	A11.4.1.1	First Infringement	€ 100			X
			Repeating Offenses	€ 250			
40	Not pouring waste oil and fluids to designated barrels	A11.4.1.1	First Infringement	€ 100			X
			Repeating Offenses	€ 250			
41	Smoke and throwing away rubbish/stub on the itinerary of the route and on the pre-start areas, Starts and Finishes of selective sections	A11.4.1.1	First Infringement	€ 50			X
			Repeating Offenses	€ 100			
42	Throwing rubbish and lighting a fire outside the designated areas on the bivouac / service park	A11.4.1.2	First Infringement	€ 50			X
			Repeating Offenses	€ 250			
43	Cutting corners or making manoeuvres over the fields, forests, orchards or marshes	A11.4.1.3	First Infringement	€ 500	15 Minute		X
			Repeating Offenses				
44	Destroying the fences, gates and barriers located along the route	A11.4.1.3	First Infringement	€ 500	15 Minute		X
			Repeating Offenses				
45	Not paying cash penalties, Within 48 hours Within 24 hours (Leg 7) In the same day (Leg 8)					Start Denied Start Denied Out of Standings	

## Annex 4 Stella Tracking System Manuel

### MAIN SCREEN



### SPEED ZONE

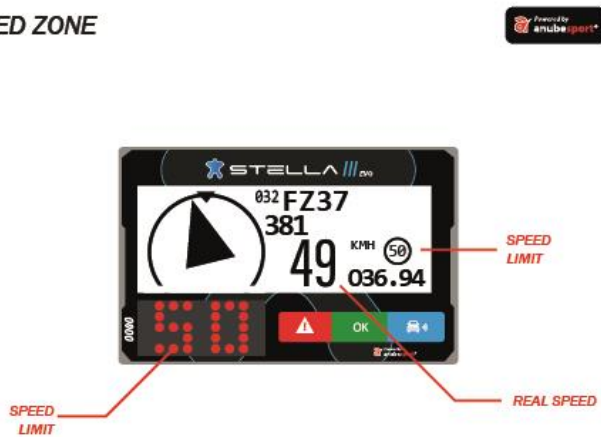

### WAYPOINT PROXIMITY



REQUEST MEDICAL ATTENTION IMMEDIATELY

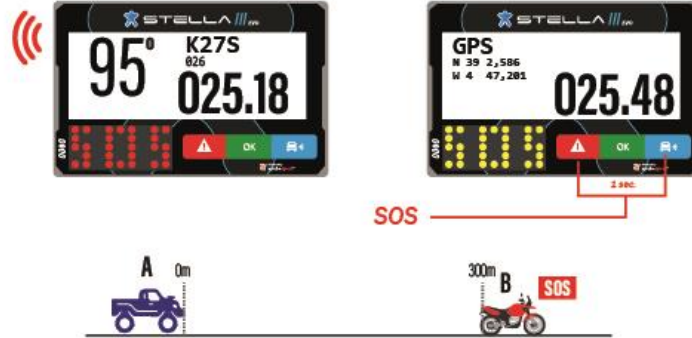

CAUTION VEHICLE STATIONARY

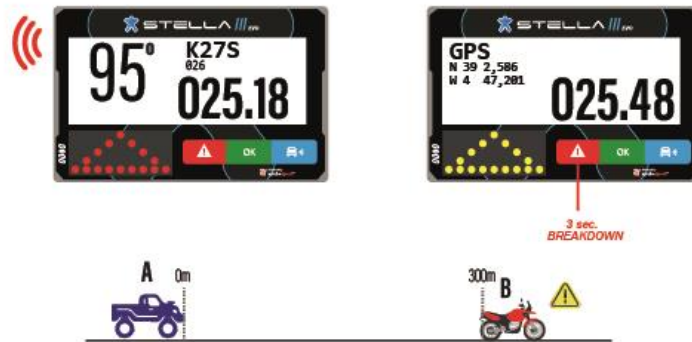

DANGER 3 !!!



Notification 300m before an area marked in the roadbook as "Danger 3"

## OVERTAKING / BLUE FLAG



FLASHING

OVERTAKE REQUEST



## OVERTAKING / BLUE FLAG



STEADY



FLASHING



## OVERTAKING / BLUE FLAG



FREE TO OVERTAKE



STEADY

PRESS THE BLUE BUTTON TO CONFIRM



SPEED LIMIT



SPEED LIMIT



SPEED LIMIT

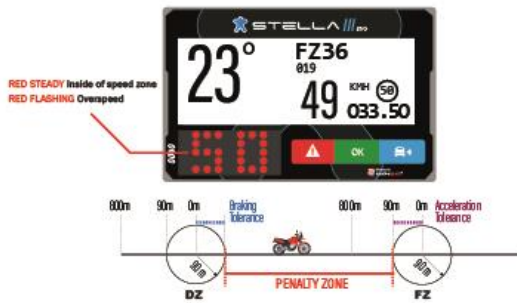

SPEED LIMIT

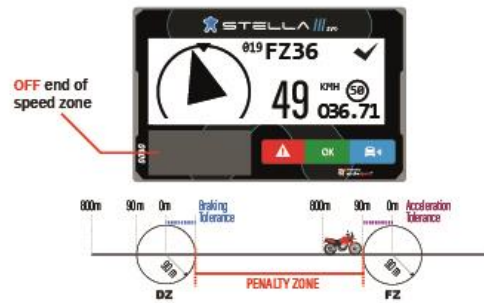

WAYPOINTS LIST



## MESSAGES



## TOTAL ODOMETER RESET TO ZERO



OK

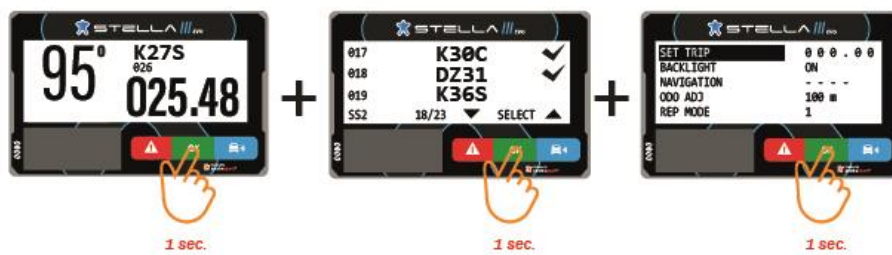

## **Annex 5 First Aid Kit**























The first aid kit should be placed in an easily recognizable bag produced in distinctive colours in accordance with international standards. It should be fixed and stored in an easily accessible area by competitors and third parties.

**The materials that should be included in the First Aid Kit are listed as follows:**

- 1 Pair**     Stainless Steel Scissors
- 1**         Medical Plaster **(5 m X 2.5 cm)**
- 2**         Bandage (Bigger Size) **(5 m X 10 cm)**
- 3**         Triangular Bandage
- 1 Pack**    Sterile Compress **(10 cm X 10 cm) (50 adet)**
- 1**         Self-Adhering Coban Bandage **(4 m X 8 cm)**
- 2**         Aluminium Emergency Blanket **(160 cm X 210 cm)**
- 2**         Finger Plaster **(12 cm X 2 cm)**
- 4 Pair**    Single Use Nitril Gloves
- 1 Pack**    Wet Wipes
- 4 Dozes**   Physiological Saline for Eyes
- 1**         Skin Disinfectant **(50 ml)**
- 2**         Compression Bandages: Emergency Haemostatic Compression Pad
- 1**         Tourniquet (One-Handed Operation)
- 1**         Information Sheet
- 1**         Emergency Procedure Sheet
- 1**         Critical Burn Kit For Face And Hands
- 1**         Sunscreen **(50 ml)**
- 1**         Headlamp
- 1**         Emergency Mirror
- 1**         Whistle



## Annex 7 Signage

KONTROL TİPİ CONTROL TYPE	KONTROL NOKTASI (Sembolün çapı 70 cm) CONTROL ZONE (Diameter of signal about 70 cm)		
Yarış yönü Direction of route	→		
	←		
	KAPALI PARK KURALLARI GEÇERLİ BÖLGE PARC FERME RULES APPLY		
	SARI TABELA - Nokta girişi YELLOW SIGNS - Zone entry	KIRMIZI TABELA - Zorunlu durma noktası RED SIGNS - Compulsory stop	BEJ DIAGONAL Nokta sonu BEIGE SIGNS - End of zone
PASAJ KONTROL PASSAGE CONTROL	 ← 25 m (min) →	 ← 25 m →	
ZAMAN KONTROL (ZK) TIME CONTROL (TC)	 ← 25 m (min) →	 ← 25 m →	
ZK - SERVİS GİRİŞ TC AT SERVICE PARK ENTRANCE	 ← 5 m →	 ← 5 m →	
ZK - SERVİS ÇIKIŞ TC AT SERVICE PARK EXIT	 ← 5 m →	 ← 5 m →	
ÖZEL ETAP ZK VE START TC AND SS START	 ← 25 m (min) →	 ← 50-200 m →	 ← 25 m →
ÖZEL ETAP FINISH VE STOP FINISHES OF SS	 ← 100 m →	 ← 150-300 m → FF NOKTASI (DURMA) FLYING FINISH (NO STOP)	 ← 25 m →
	MAVİ ARKAPLANDA SIYAH SEMBOL BLACK SYMBOL ON A BLUE BACKGROUND		
YAKIT İKMAL ALANI REFUELING ZONE		YAKIT İKMAL ALANI TABELASI; Yakıt ikmaline yalnızca bu bölge içerisinde izin verilir. (Halka açık yakıt istasyonları hariç) REFUELING ZONE SIGN; Only refueling allowed in this zone. (Not on public fuel stations)	
SERVİS ALANI SERVICE ZONE		SERVİS ALANI TABELASI; Servis Alanı/Bivouac dışında yalnızca (varsa) bu bölge içerisinde servis alınabilir. SERVICE ZONE SIGN; Sign for service operations outside the Service Park/Bivouac	

## Annex 8 Sportity App

### STEP 1:

**'DOWNLOAD'** Sportity App  
*Sportity Uygulamasını indir.*



Sportity



### STEP 2:



For direct event information  
please insert this **'PASSWORD'** :

*Yarışma dokümanlarına ulaşmak için  
aşağıdaki şifreyi gir.*

**TransAnatolia23CARS** : CARS / SSV / TRUCKS (RALLY)  
**TransAnatolia23BIKES** : BIKES / QUADS (RALLY)  
**TransAnatolia23RAID** : RAID

### STEP 3:



Quick information delivery with push  
notifications when files are uploaded.

*Dosya yüklendiğinde telefonunuza gönderilecek  
bildirimler ile dokümanlara anında ulaş.*

Documents are available also offline

*Ayrıca uygulama sayesinde, görüntülenen dosyalara  
çevrimdışı olarak da ulaşarak daima bilgili kal.*